

M-30/30/15 WZM

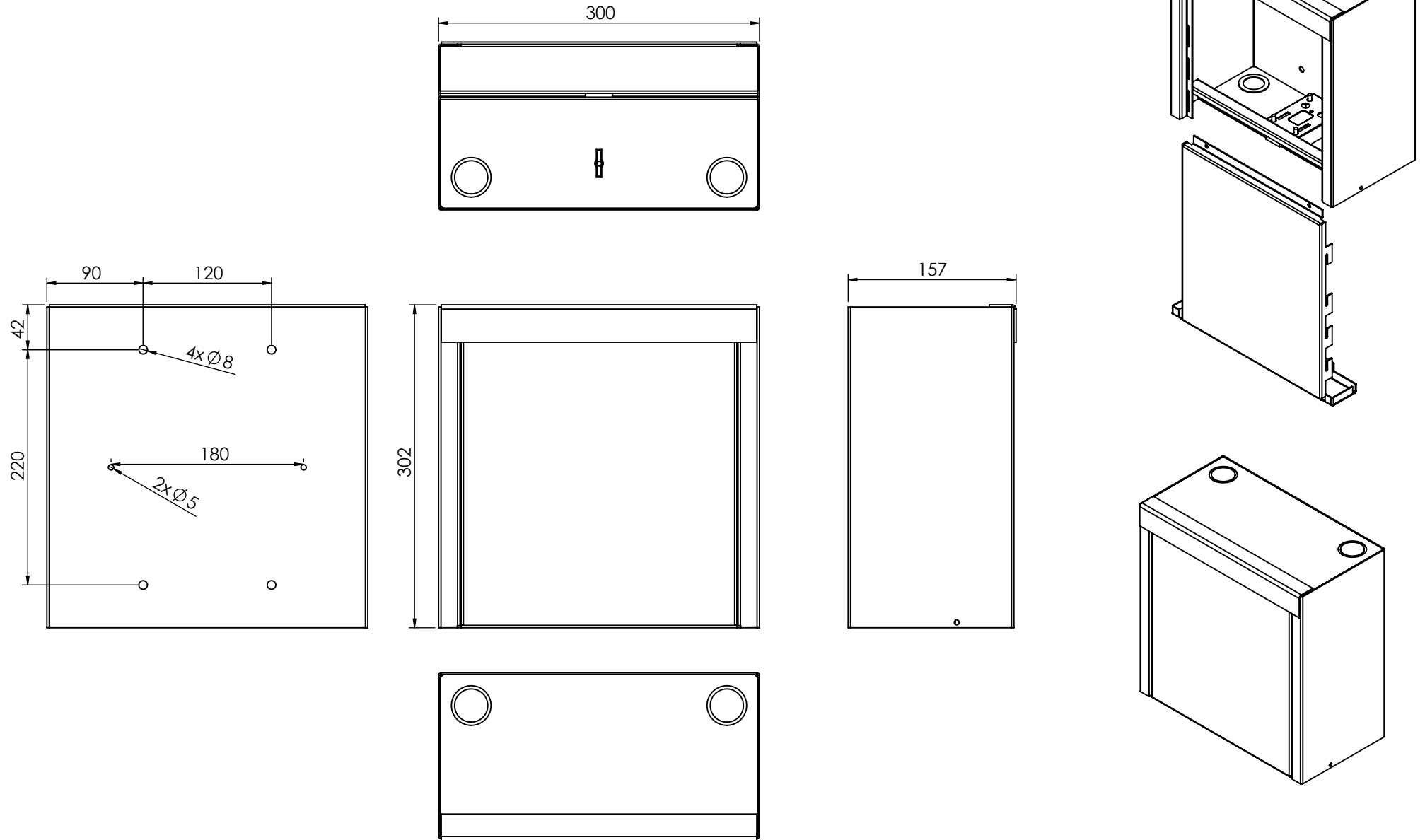

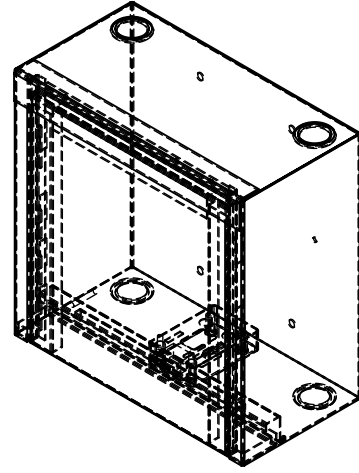

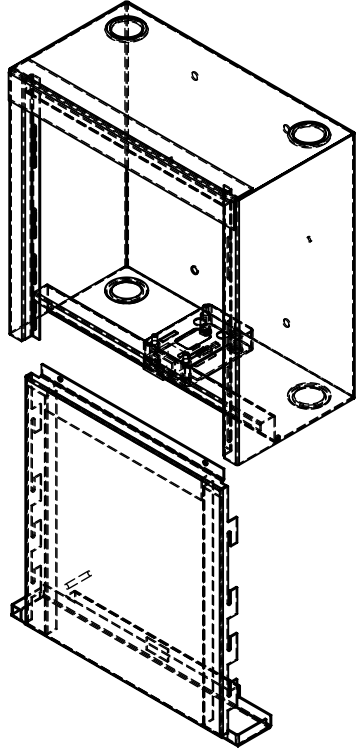
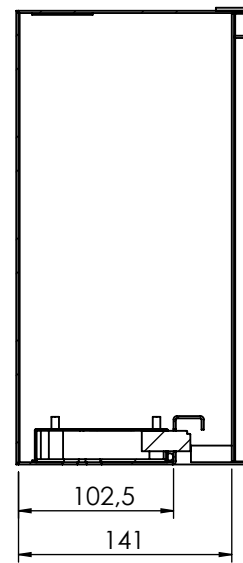
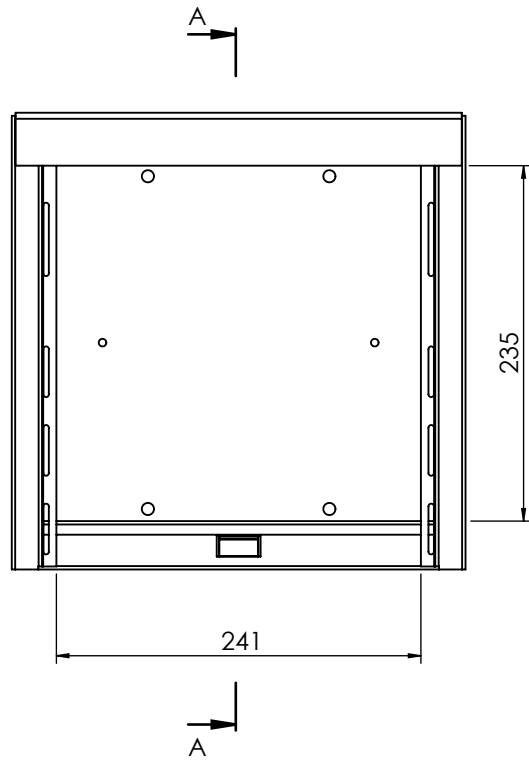

PRZEKRÓJ A-A